

## Prescott Action Shooters-Whiskey Row Gunslinger Stage Conventions

1. All competitors are required to attend the safety briefing prior to the day's match.
2. All competitors are required to sign the waiver form prior to participating in the day's match.
3. Shotguns are staged open and empty unless specific stage instructions indicate otherwise.
4. Both revolvers are loaded with 5 rounds each and holstered, hammer down on an empty chamber unless stage instructions indicate otherwise.
5. Rifles are loaded with specified number of rounds for the stage, hammer down on empty chamber.
6. Both feet must be behind the prop at the starting position, after the beep shooter may move to engage the targets, one foot is to remain behind the prop at the position for the gun string.
7. All long guns are to be carried from the loading table to the line and back to the unloading table at the conclusion of the stage with muzzles above the shoulders, barrels point slightly down range to avoid breaking the 170° cone.
8. All long guns to be staged flat on the prop prior to target engagement, they must be re-staged safely at the conclusion of the shooting string.
9. All guns must be checked at the unloading table prior to returning them to a gun cart, failure to do so will result in a stage DQ.
10. A round fired over the rear or side berms will result in a match DQ, shooter will be done for the day. **Note:** This does NOT apply to shotgun rounds fired at a launched target.

Stage 1:  
January 2023: **Happy New Year!**



**DAGNABIT!**

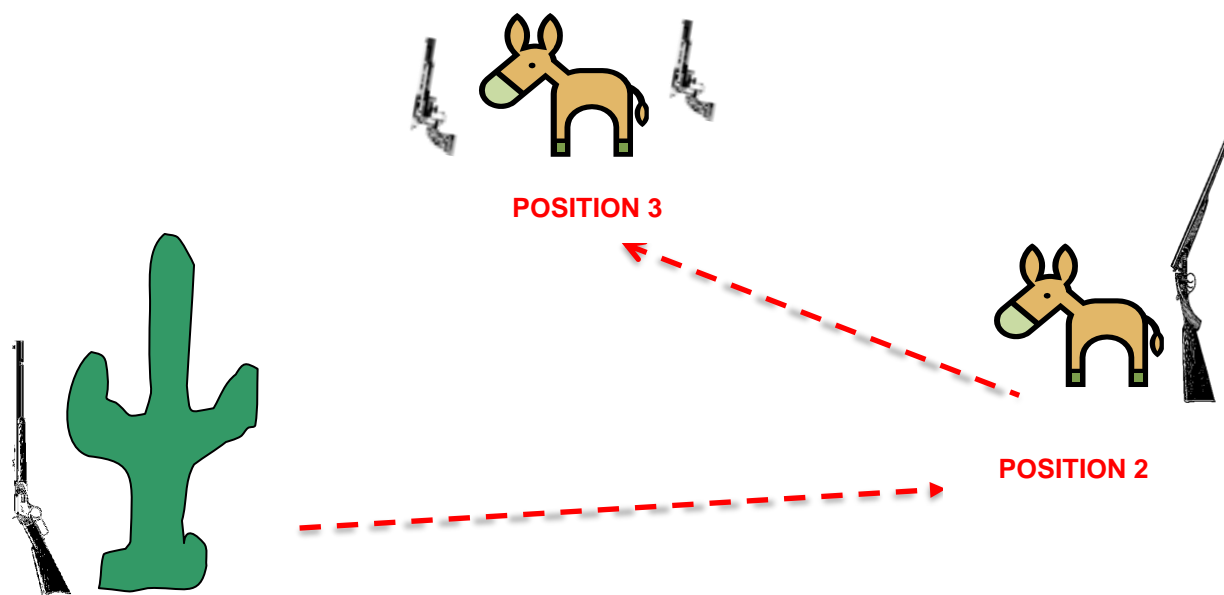
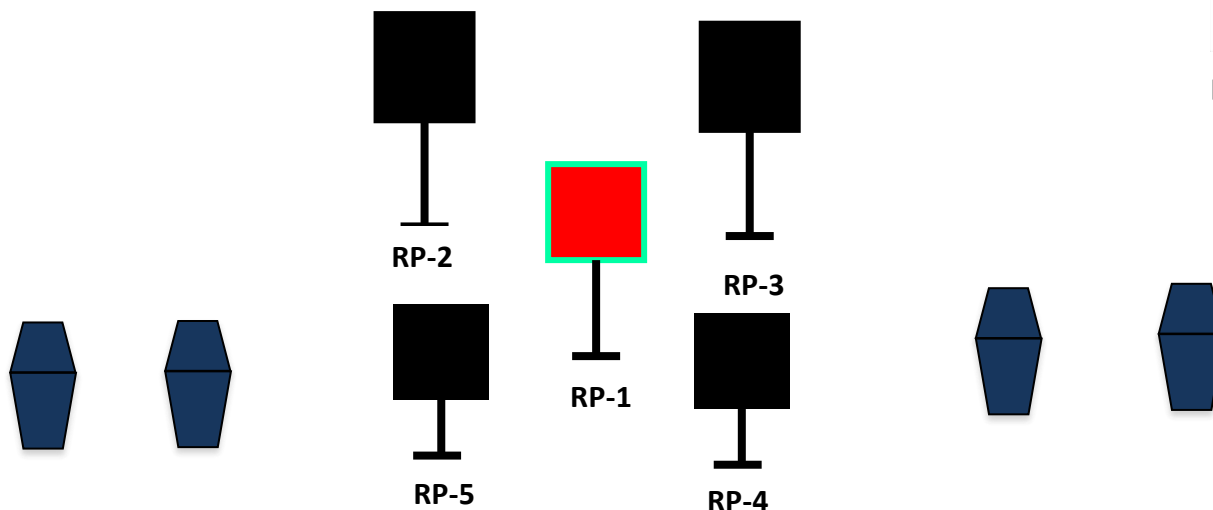

**STAGING OF FIREARMS:**

**BOTH REVOLVERS LOADED & HOLSTERED, RIFLE LOADED & STAGED SAFELY ON THE CACTUS, SHOTGUN STAGED SAFELY AT POSITION 2.**

**HOW TO SHOOT THE STAGE:**

**SHOOTER STARTS STANDING AT THE CACTUS WITH THUMBS HOOKED IN A BELT. SHOOTER INDICATES READY BY SAYING: "MY HEAD HURTS!"**

**AT THE BEEP FROM THE CACTUS ENGAGE THE RIFLE TARGETS BY SINGLE TAPPING RP1 THEN DOUBLE TAPPING EACH OUTSIDE TARGET (ANY ORDER) THEN SINGLE TAP RP1 FOR 10 ROUNDS. FROM POSITION 2 WITH YOUR SHOTGUN, ENGAGE THE 2 KNOCKDOWNS IN FRONT OF YOU, MOVE UP TO POSITION 3 AND ENGAGE THE REMAINING 2 KNOCKDOWNS. FROM POSITION 3 WITH REVOLVERS ENGAGE THE 5 RP TARGETS WITH THE SAME INSTRUCTIONS AS THE RIFLE TARGETS.**

**END OF STAGE**

**NOTE: ONE FOOT MUST BE BEHIND THE PROP WHILE ENGAGING TARGETS**

**GUN ORDER: RIFLE, SHOTGUN, REVOLVERS**

**REVOLVERS (10)**

**RIFLE (10)**

**SHOTGUN (4+)**

# Stage 2

January 2023: **Happy New Year!**



**DAGNABIT!**

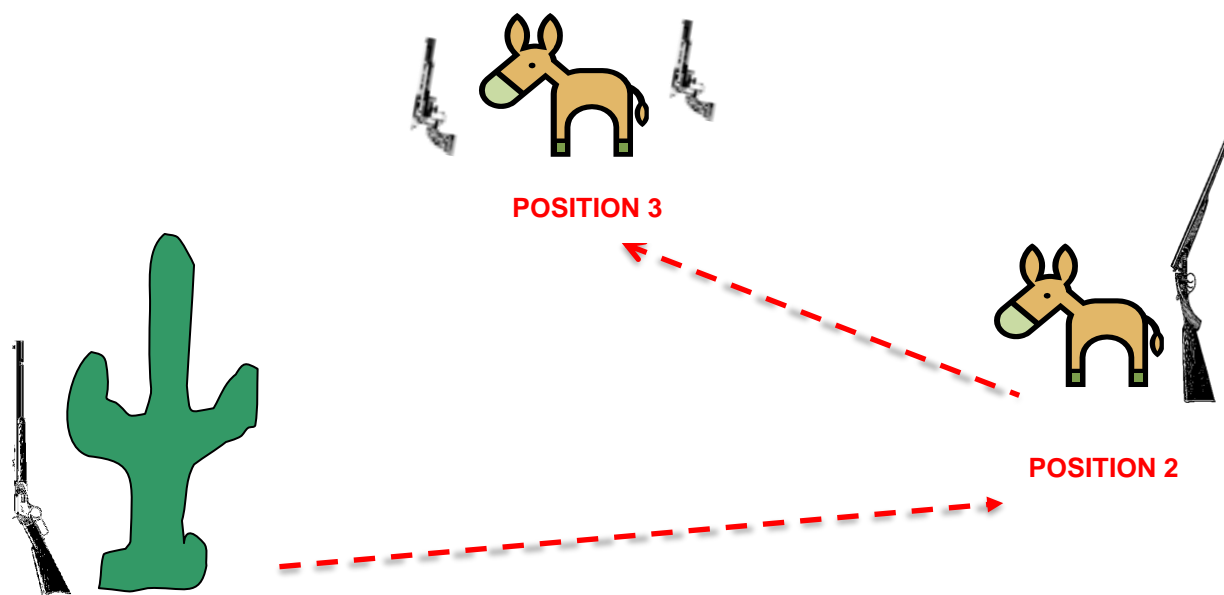
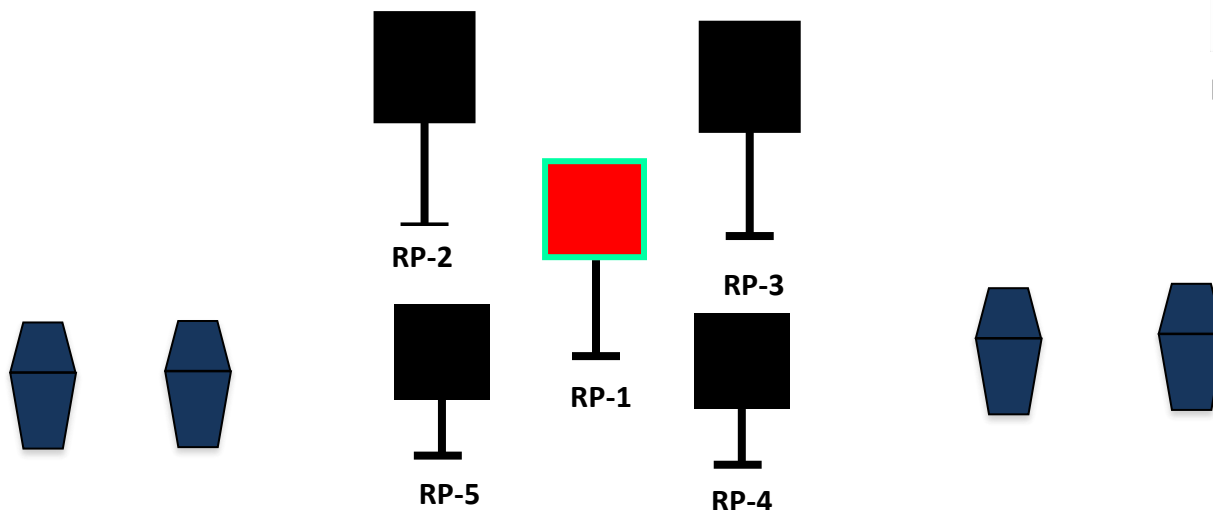

**STAGING OF FIREARMS:**

**BOTH REVOLVERS LOADED & HOLSTERED, RIFLE LOADED & STAGED SAFELY ON THE CACTUS, SHOTGUN STAGED SAFELY AT POSITION 2.**

**HOW TO SHOOT THE STAGE:**

**SHOOTER STARTS STANDING AT THE CACTUS WITH HANDS AT LOW SURRENDER. SHOOTER INDICATES READY BY SAYING: *"I SHOULDN'T HAVE DRUNK THAT HEAD BUSTING LIQUOR DOWN ON WHISKEY ROW!"* AT THE BEEP FROM THE CACTUS ENGAGE THE RIFLE TARGETS IN A "X" PATTERN BY SINGLE TAPPING AN OUTSIDE TARGET THEN TRIPLE TAPPING RP1 THEN SINGLE TAP THE OTHER TARGET, (1-3-1). EXAMPLE: RP2, RP1-RP1-RP1, RP4. THEN USING THE OTHER OUTSIDE TARGETS REPEAT THE "X" WITH THE SAME SEQUENCE. FROM POSITION 2 WITH YOUR SHOTGUN, ENGAGE THE 2 KNOCKDOWNS IN FRONT OF YOU, MOVE UP TO POSITION 3 AND ENGAGE THE REMAINING 2 KNOCKDOWNS. FROM POSITION 3 WITH REVOLVERS ENGAGE THE 5 RP TARGETS WITH THE SAME INSTRUCTIONS AS THE RIFLE TARGETS.**

**END OF STAGE**

***NOTE: ONE FOOT MUST BE BEHIND THE PROP WHILE ENGAGING TARGETS***

**GUN ORDER: RIFLE, SHOTGUN, REVOLVERS**

**REVOLVERS (10)**

**RIFLE (10)**

**SHOTGUN (4+)**

STAGE 3:  
January 2023: **Happy New Year!**



**DRAW!**

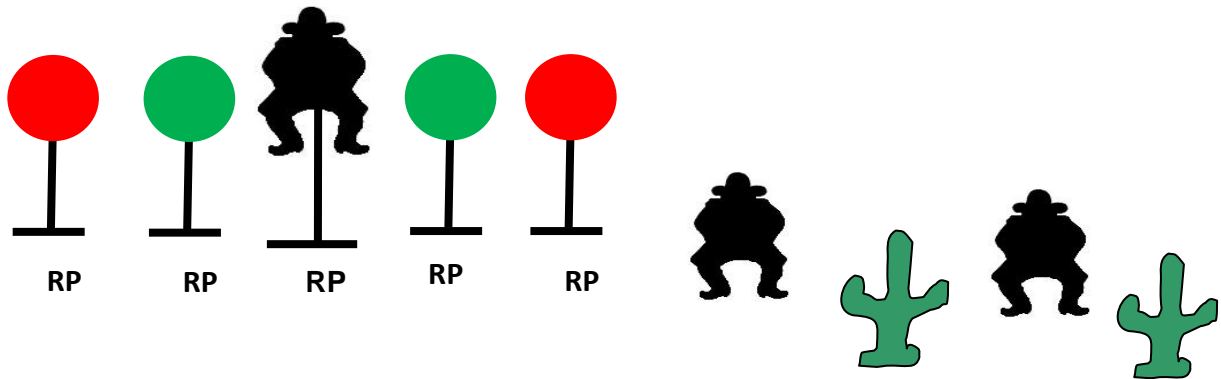

**POSITION 3**

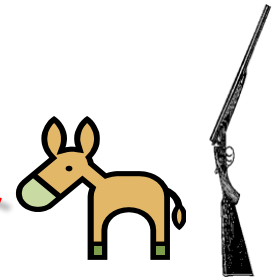

**POSITION 2**

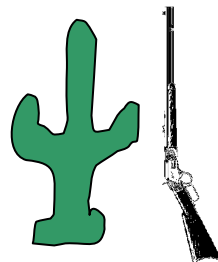

**POSITION 1**

**STAGING OF FIREARMS:**

RIFLE LOADED IN HANDS AT POSITION 1, SHOTGUN STAGED AT POSITION 2, REVOLVERS LOADED & HOLSTERED.

**HOW TO SHOOT THE STAGE:**

SHOOTER STARTS AT POSITION 1 WITH RIFLE IN HANDS, SHOOTER INDICATES READY BY SAYING **"I WISH I KNEW WHERE I LEFT MY HORSE!"**

AT THE BUZZER WITH RIFLE WHISKEY ROW SWEEP THE 5 RP TARGETS, STARTING ON EITHER END FOR A TOTAL OF 10 ROUNDS. MAKE RIFLE SAFE VERTICALLY AT THE CACTUS, HEAD TO POSITION 2. WITH SHOTGUN ENGAGE THE FOUR SHOTGUN TARGETS IN FRONT OF THAT POSITION IN ANY ORDER, MOVE TO POSITION 3 WITH REVOLVERS REPEAT THE RIFLE INSTRUCTIONS ON THE 5 RP TARGETS.

**WHISKEY ROW SWEEP:** DOUBLE TAP AN END TARGET, THEN SWEEP THE 3 MIDDLE TARGETS TWICE FROM THE SAME DIRECTION, THEN DOUBLE TAP THE OTHER END TARGET.

**END OF STAGE**

**NOTE: ONE FOOT MUST BE BEHIND THE PROP WHILE ENGAGING TARGETS**

**GUN ORDER: RIFLE, REVOLVERS, SHOTGUN**

**REVOLVERS (10)**

**RIFLE (10)**

**SHOTGUN (4+)**

STAGE 4:  
January 2023: *Happy New Year!*



**DRAW!**

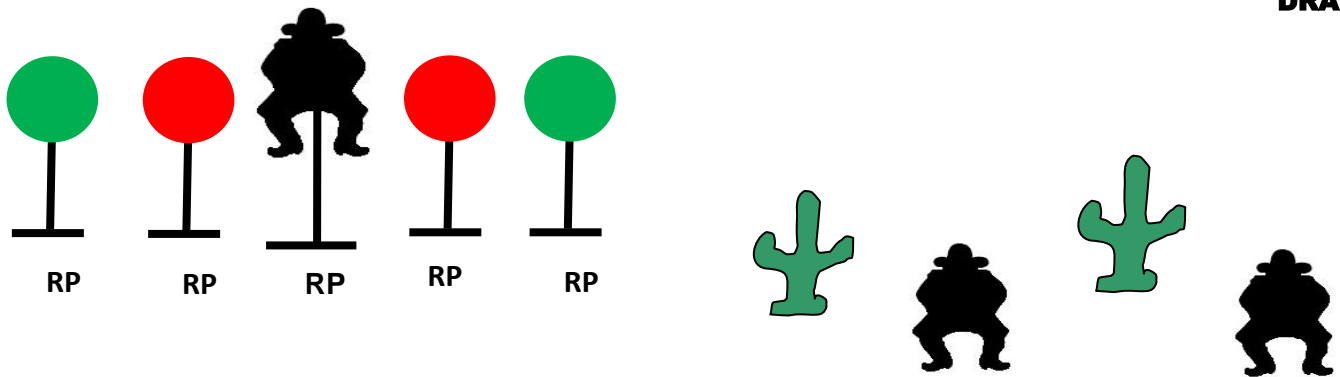

**POSITION 3**

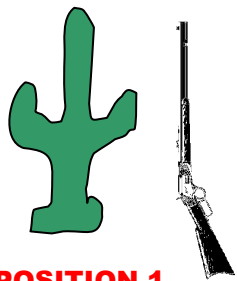

**POSITION 1**

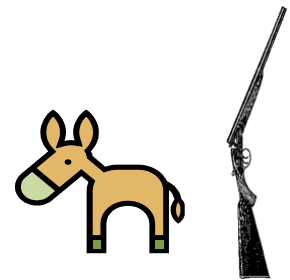

**POSITION 2**

**STAGING OF FIREARMS:**

RIFLE STAGED ON THE CACTUS AT POSITION 1, SHOTGUN STAGED AT POSITION 2, REVOLVERS LOADED & HOLSTERED.

**HOW TO SHOOT THE STAGE:**

SHOOTER STARTS AT POSITION 1 AT THE READY, SHOOTER INDICATES READY BY SAYING **"I HAVE TO FIND MY HORSE!"**

AT THE BUZZER WITH RIFLE SINGLE TAP THE CENTER COWBOY THEN DOUBLE TAP THE 2 RIGHT HAND CIRCLES, THEN SINGLE TAP THE COWBOY AND DOUBLE TAP THE 2 LEFT HAND CIRCLES FOR A TOTAL OF 10 ROUNDS. **NOTE:** SHOOTER MAY CHOOSE THE RIGHT OR LEFT HANDSET OF 3 TARGETS FIRST. MAKE RIFLE SAFE VERTICALLY AT THE CACTUS, HEAD TO POSITION 2. WITH SHOTGUN ENGAGE THE 4 SHOTGUN TARGETS IN THIS ORDER: CACTUS-COWBOY, CACTUS-COWBOY UNTIL DOWN. FROM POSITION 3 WITH REVOLVERS, REPEAT THE RIFLE INSTRUCTIONS ON THE 5 RP TARGETS FOR 10 ROUNDS, HOLSTER. FROM POSITION 3 END OF STAGE

**NOTE: ONE FOOT MUST BE BEHIND THE PROP WHILE ENGAGING TARGETS  
GUN ORDER: RIFLE, SHOTGUN, REVOLVERS**

**REVOLVERS (10)**

**RIFLE (10)**

**SHOTGUN (4+)**

STAGE 5:  
January 2023: **Happy New Year!**



**DRAW!**

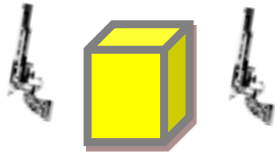
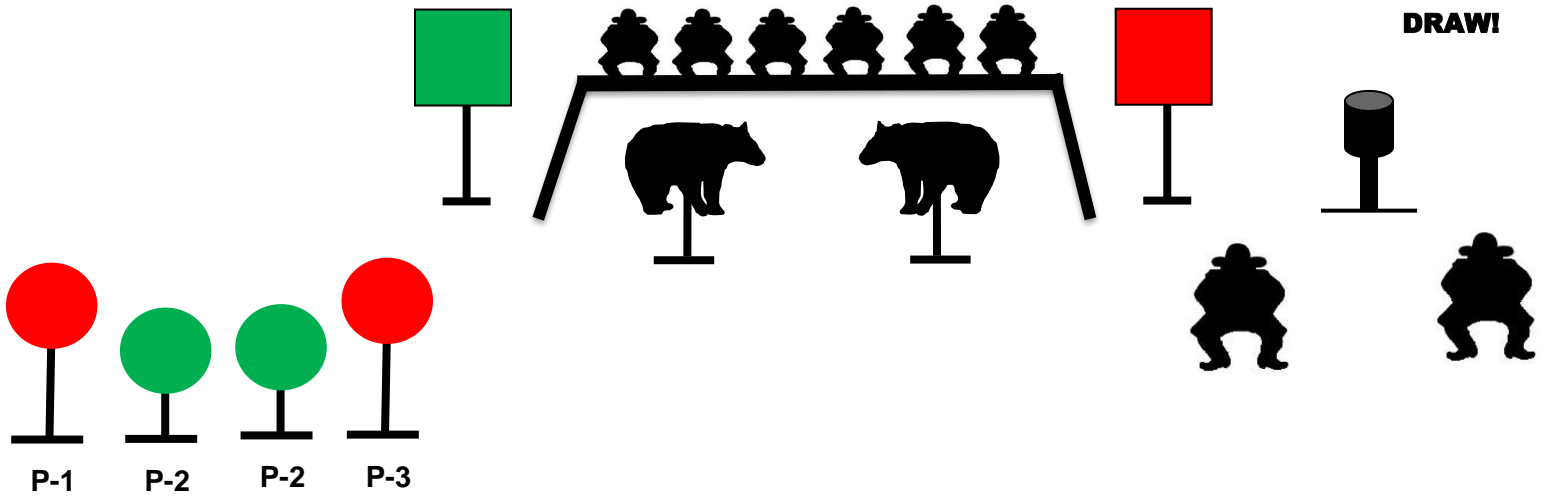

**POSITION L**



**POSITION R**

**STAGING OF FIREARMS:**

RIFLE LOADED & OPEN EMPTY SHOTGUN STAGED AT POSITION R, REVOLVERS LOADED & HOLSTERED. **NOTE:** STAGE MAY BE SHOT IN ANY ORDER, RIFLE MAY NOT BE LAST.

**HOW TO SHOOT THE STAGE:**

START STANDING AT POSITION RIGHT OR LEFT WITH HANDS ON THE PROP, SHOOTER INDICATES READY BY SAYING: **“WELL THERE’S MY SADDLE!”**

AT THE BEEP, FROM POSITION L, WITH REVOLVERS, ENGAGE THE REVOLVER TARGETS IN A 1-3-1-5 SWEEP STARTING FROM EITHER END.

FROM THE WATER TROUGH, WITH RIFLE ENGAGE THE 4 STATIONARY TARGETS AND THE 6 COWBOYS ON THE RACK FOR A TOTAL OF 10 ROUNDS.

**NOTE:** IF ANY KNOCKDOWNS REMAIN STANDING FROM THE COWBOY PLATE RACK YOU MAY MAKE UP BY ENGAGING THE BELL WITH YOUR SHOTGUN AT THE END OF THE SHOTGUN STRING.

WITH YOUR SHOTGUN, ENGAGE THE BELL AND 1 COWBOY, THEN THE BELL AND THE OTHER COWBOY, (NO DOUBLE TAPS ON THE BELL).

**NOTE:** ANY RIFLE KNOCKDOWNS THAT REMAIN STANDING OR ARE NOT MADE UP WITH THE SHOTGUN WILL COUNT AS MISSES.

END OF STAGE

**NOTE: ONE FOOT MUST BE BEHIND THE PROP WHILE ENGAGING TARGETS**  
**GUN ORDER: ANY, RIFLE MAY NOT BE LAST**

**REVOLVERS (10)**

**RIFLE (10)**

**SHOTGUN (4+)**

# STAGE 6: January 2023: Happy New Year!



**DRAW!**

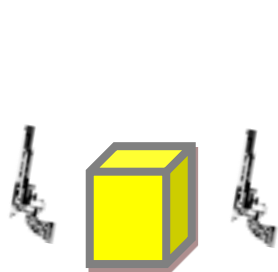
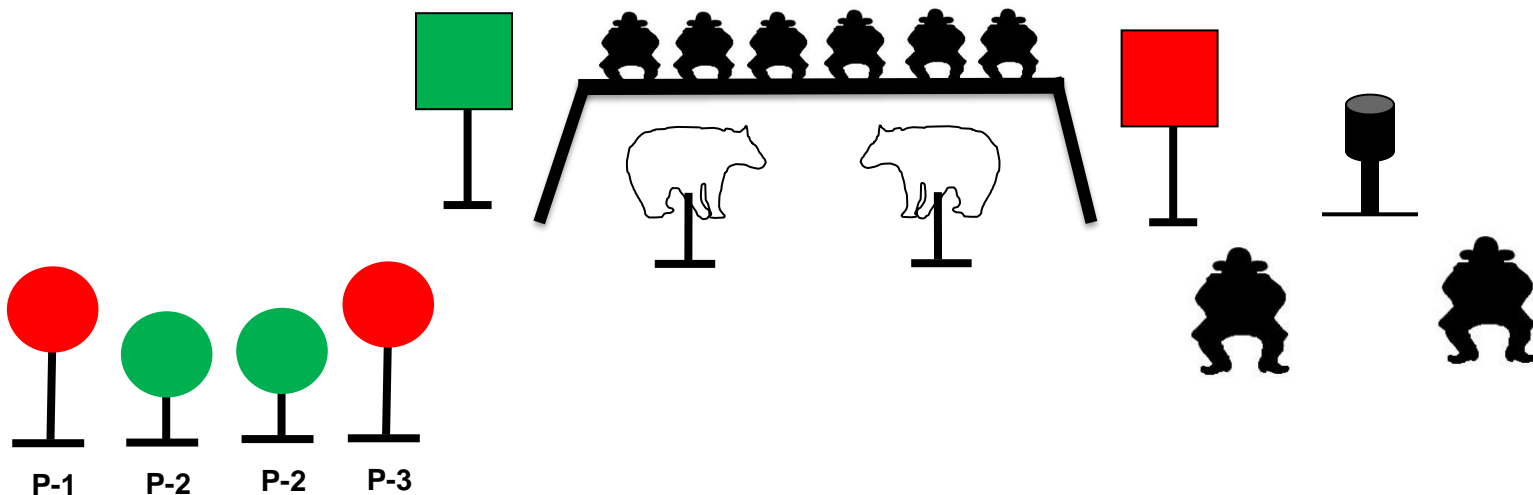

**POSITION 1**

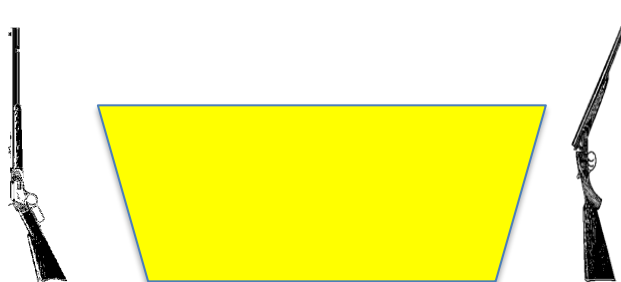

**POSITION 2**

## **STAGING OF FIREARMS:**

RIFLE LOADED & OPEN EMPTY SHOTGUN STAGED AT POSITION 2, REVOLVERS LOADED & HOLSTERED.

## **HOW TO SHOOT THE STAGE:**

START STANDING AT POSITION 1 WITH HAND(S) ON THE REVOLVER(S), SHOOTER INDICATES READY BY SAYING: **“THERE MY HORSE, RIGHT IN FRONT OF THE PALACE!”**

AT THE BEEP, FROM POSITION 1, WITH REVOLVERS ENGAGE THE REVOLVER TARGETS IN A PROGRESSIVE SWEEP STARTING FROM EITHER END, I.E.: P1, P2-P2, P3-P3-P3, P4-P4-P4-P4.

FROM THE WATER TROUGH, WITH RIFLE DOUBLE TAP ONE OF SQUARE STATIONARY TARGETS THEN THE 6 COWBOYS ON THE RACK, THEN DOUBLE TAP THE REMAINING SQUARE FOR A TOTAL OF 10 ROUNDS. **NOTE:** BEARS ARE NOT IN PLAY ON THIS STAGE.

**NOTE:** IF ANY KNOCKDOWNS REMAIN STANDING FROM THE COWBOY PLATE RACK YOU MAY MAKE THEM UP BY ENGAGING THE BELL WITH YOUR SHOTGUN AT THE END OF THE SHOTGUN STRING. WITH YOUR SHOTGUN, ENGAGE THE BELL AND 1 COWBOY, THEN THE BELL AND THE OTHER COWBOY (NO DOUBLE TAPS ON THE BELL).

**NOTE:** ANY RIFLE KNOCKDOWNS THAT REMAIN STANDING OR ARE NOT MADE UP WITH THE SHOTGUN WILL COUNT AS MISSES.

**END OF STAGE**

**NOTE: ONE FOOT MUST BE BEHIND THE PROP WHILE ENGAGING TARGETS**  
**GUN ORDER: REVOLVERS, RIFLE, SHOTGUN**

**REVOLVERS (10)**

**RIFLE (10)**

**SHOTGUN (4+)**

# *Target and Prop Requirements*

## *WRG, January 2023*

### **Stages 1 & 2**

Rifle & Revolver Targets:  
Five 20" Squares

Stands:  
5

Props:  
Cactus, 2 Gun Horses, 1 low Horse

Shotgun Targets:  
4 Coffin Knockdowns

### **Stages 3 & 4**

Rifle & Revolver Targets:  
Four 20" Circles, Cowboy

Stands:  
5

Props:  
Cactus, Gun Horse, Sawhorse

Shotgun Targets:  
2 Cowboys, 2 Cacti

### **Stages 5 & 6**

Rifle & Revolver Targets:  
Four 20" Circles, Two 18" Squares  
Two Bears

Stands:  
8

Props:  
Water Trough, Gun Horse

Shotgun Targets:  
2 Cowboys, Bell

### **Totals**

**Shotgun Targets:**  
8 Cowboys, 2 Cacti, 2 Coffin Lids

**Props:** 5 Gun Horses, Water Trough, Sawhorse