

Prescott Action Shooters-Whiskey Row Gunslinger Stage Conventions

1. All competitors are required to attend the safety briefing prior to the day's match.
2. All competitors are required to sign the waiver form prior to participating in the day's match.
3. Shotguns are staged open and empty unless specific stage instructions indicate otherwise.
4. Both revolvers are loaded with 5 rounds each and holstered, hammer down on an empty chamber unless stage instructions indicate otherwise.
5. Rifles are loaded with specified number of rounds for the stage, hammer down on empty chamber.
6. Both feet must be behind the prop at the starting position, after the beep shooter may move to engage the targets, one foot is to remain behind the prop at the position for the gun string.
7. All long guns are to be carried from the loading table to the line and back to the unloading table at the conclusion of the stage with muzzles above the shoulders, barrels point slightly down range to avoid breaking the 170° cone.
8. All long guns to be staged flat on the prop prior to target engagement, they must be re-staged safely at the conclusion of the shooting string.
9. All guns must be checked at the unloading table prior to returning them to a gun cart, failure to do so will result in a stage DQ.
10. A round fired over the rear or side berms will result in a match DQ, shooter will be done for the day. **Note:** This does NOT apply to shotgun rounds fired at a launched target.

Stage 1: January 2022



DAGNABIT!

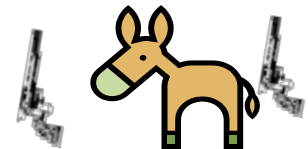
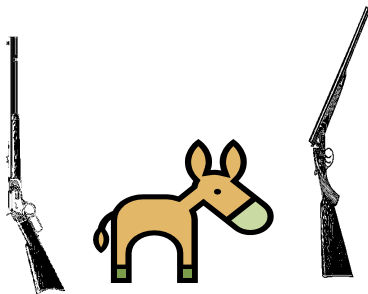
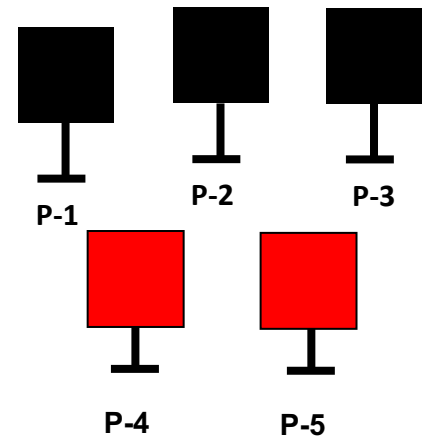
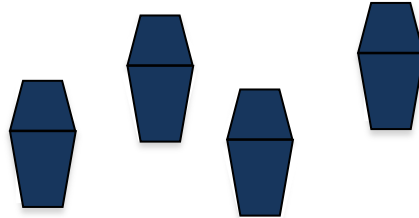
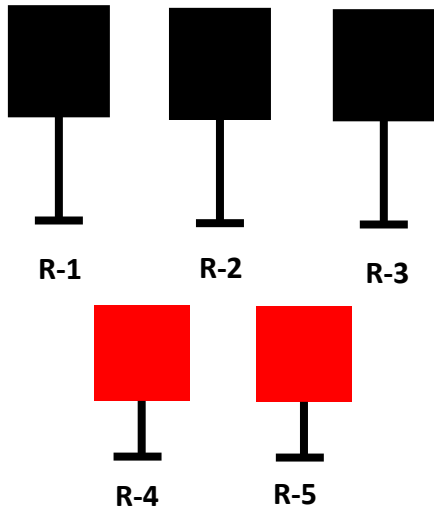

STAGING OF FIREARMS:

BOTH REVOLVERS LOADED & HOLSTERED, RIFLE LOADED & STAGED SAFELY ON THE LEFT HORSE, SHOTGUN STAGED SAFELY ANYWHERE.

HOW TO SHOOT THE STAGE:

STAGE MAY BE SHOT FROM RIGHT TO LEFT OR LEFT TO RIGHT, SHOOTER'S CHOICE, RIFLE MAY NOT BE LAST.

SHOOTER STARTS STANDING AT POSITION RIGHT OR LEFT WITH THUMBS HOOKED IN A BELT, SHOOTER INDICATES READY BY SAYING: *"KILLING A MAN IS A HELL-OF-A THING TO DO!"*

AT THE BEEP FROM THE LEFT HORSE ENGAGE THE RIFLE TARGETS BY SINGLE TAPPING R1-R3 THEN DOUBLE TAP R4 & R5, THEN SINGLE TAP R1-R3 FOR A TOTAL OF 10 ROUNDS. WITH YOUR SHOTGUN, ANYWHERE BETWEEN THE LEFT AND RIGHT POSITIONS, ENGAGE THE 4 KNOCKDOWNS UNTIL DOWN. WITH REVOLVERS ENGAGE THE 5 REVOLVER TARGETS WITH THE SAME INSTRUCTIONS AS THE RIFLE TARGETS.

END OF STAGE

NOTE: ONE FOOT MUST BE BEHIND THE PROP WHILE ENGAGING TARGETS

GUN ORDER: ANY, RIFLE MUST NOT BE LAST

REVOLVERS (10)

RIFLE (10)

SHOTGUN (4+)

Stage 2: January 2022



DAGNABIT!

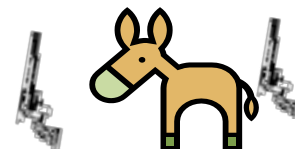
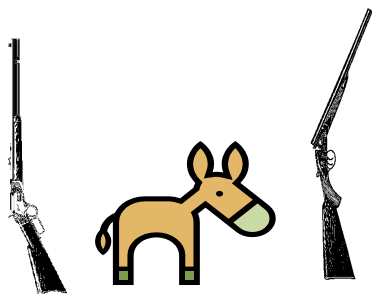
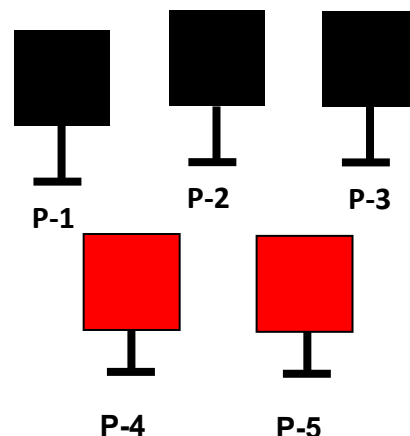
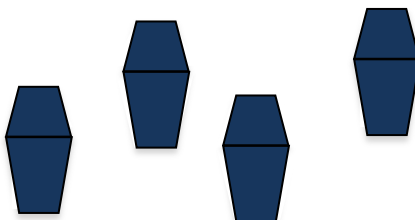
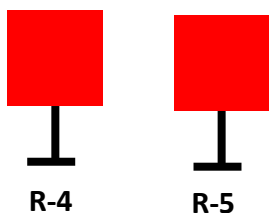
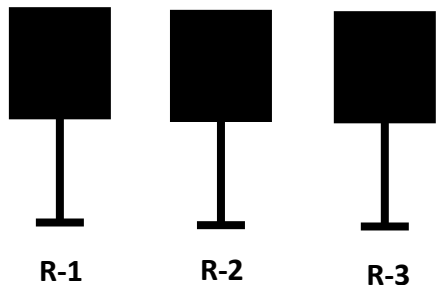

STAGING OF FIREARMS:

BOTH REVOLVERS LOADED & HOLSTERED, RIFLE LOADED IN HANDS, SHOTGUN STAGED SAFELY ANYWHERE.

HOW TO SHOOT THE STAGE:

SHOOTER STARTS STANDING AT LEFT HORSE, RIFLE IN HANDS, SHOOTER INDICATES READY BY SAYING: "WHAT DO YOU MEAN NED'S DEAD?"

AT THE BEEP FROM THE LEFT HORSE ENGAGE THE RIFLE TARGETS BY DOUBLE TAPPING R4, THEN SINGLE TAP R1-R3 IN THAT ORDER STARTING ON THE LEFT; & DOUBLE TAP R5 AND SINGLE TAP R3-R1 IN THAT ORDER FOR A TOTAL OF 10 ROUNDS. YOU MAY START WITH EITHER SET (R4, OR R5 BUT THE SWEEPS MUST BE IN OPPOSITE DIRECTIONS. WITH YOUR SHOTGUN, ANYWHERE BETWEEN THE LEFT AND RIGHT POSITIONS, ENGAGE THE 4 KNOCKDOWNS UNTIL DOWN. WITH REVOLVERS ENGAGE THE 5 REVOLVER TARGETS WITH THE SAME INSTRUCTIONS AS THE RIFLE TARGETS.

END OF STAGE

NOTE: ONE FOOT MUST BE BEHIND THE PROP WHILE ENGAGING TARGETS

GUN ORDER: RIFLE SHOTGUN, REVOLVERS

REVOLVERS (10)

RIFLE (10)

SHOTGUN (4+)

STAGE 3: January 2022



DRAW!

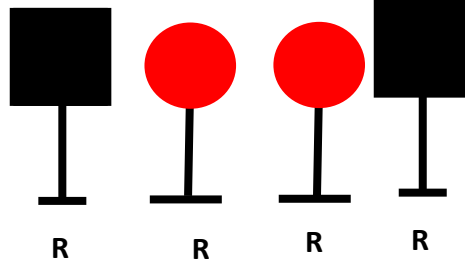
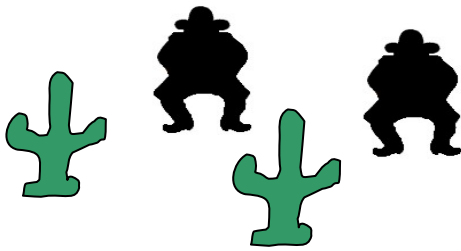

POSITION 3

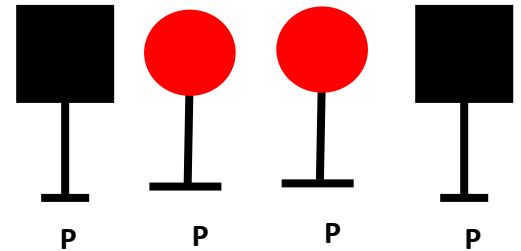

POSITION 1

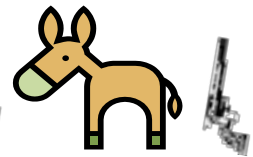

POSITION 2

STAGING OF FIREARMS:

RIFLE LOADED IN HANDS AT POSITION 1, SHOTGUN STAGED AT POSITION 2, REVOLVERS LOADED & HOLSTERED.

HOW TO SHOOT THE STAGE:

SHOOTER STARTS AT POSITION 1 WITH RIFLE IN HANDS, SHOOTER INDICATES READY BY SAYING "THE DUCK OF DEATH?"

AT THE BUZZER WITH RIFLE, ENGAGE THE RIFLE TARGETS IN A DOS UNO SWEEP STARTING ON EITHER END FOR A TOTAL OF 10 ROUNDS. MAKE RIFLE SAFE VERTICALLY AT THE CACTUS, HEAD TO POSITION 2. WITH REVOLVERS REPEAT THE RIFLE INSTRUCTIONS ON THE REVOLVER TARGETS FOR 10 ROUNDS, HOLSTER. FROM POSITION 3 WITH SHOTGUN, ENGAGE THE 4 SHOTGUN TARGETS IN ANY ORDER UNTIL DOWN.

DOS UNO SWEEP: DOUBLE TAP THE END TARGETS THEN SINGLE TAP THE CENTER TARGETS, THEN DOUBLE TAP THE END TARGETS.

END OF STAGE

NOTE: ONE FOOT MUST BE BEHIND THE PROP WHILE ENGAGING TARGETS

GUN ORDER: RIFLE, REVOLVERS, SHOTGUN

REVOLVERS (10)

RIFLE (10)

SHOTGUN (4+)

STAGE 4: January 2022



DRAW!

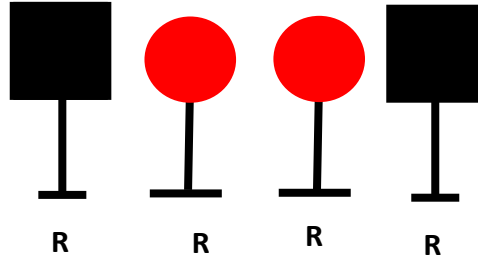
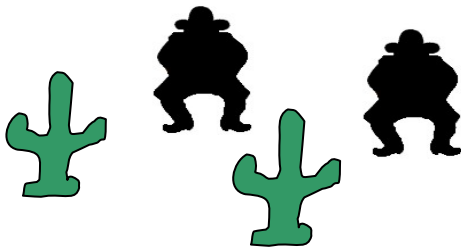

POSITION 3

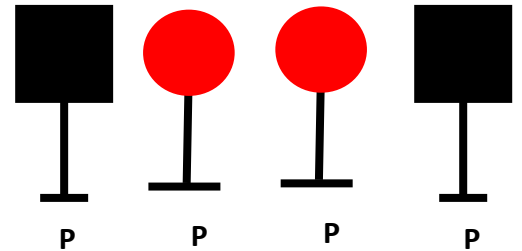

POSITION 1

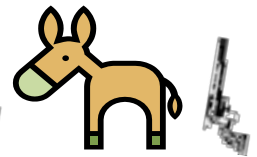

POSITION 2

STAGING OF FIREARMS:

RIFLE LOADED STAGED ON THE CACTUS AT POSITION 1, SHOTGUN STAGED AT POSITION 2, REVOLVERS LOADED & HOLSTERED.

HOW TO SHOOT THE STAGE:

SHOOTER STARTS AT POSITION 1 WITH YOUR HANDS BEHIND YOUR BACK, SHOOTER INDICATES READY BY SAYING "HEY I'M UNARMED, I'M A WRITER!"

AT THE BUZZER WITH RIFLE, ENGAGE THE RIFLE TARGETS IN 3-1-1-5 SWEEP STARTING ON EITHER END FOR A TOTAL OF 10 ROUNDS. MAKE RIFLE SAFE VERTICALLY AT THE CACTUS, HEAD TO POSITION 2. WITH REVOLVERS REPEAT THE RIFLE INSTRUCTIONS ON THE REVOLVER TARGETS FOR 10 ROUNDS, HOLSTER. FROM POSITION 3 WITH SHOTGUN, ENGAGE THE 4 SHOTGUN TARGETS IN ANY ORDER UNTIL DOWN.

END OF STAGE

**NOTE: ONE FOOT MUST BE BEHIND THE PROP WHILE ENGAGING TARGETS
GUN ORDER: RIFLE, REVOLVERS, SHOTGUN**

REVOLVERS (10)

RIFLE (10)

SHOTGUN (4+)

STAGE 5: January 2022



DRAW!

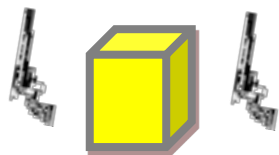
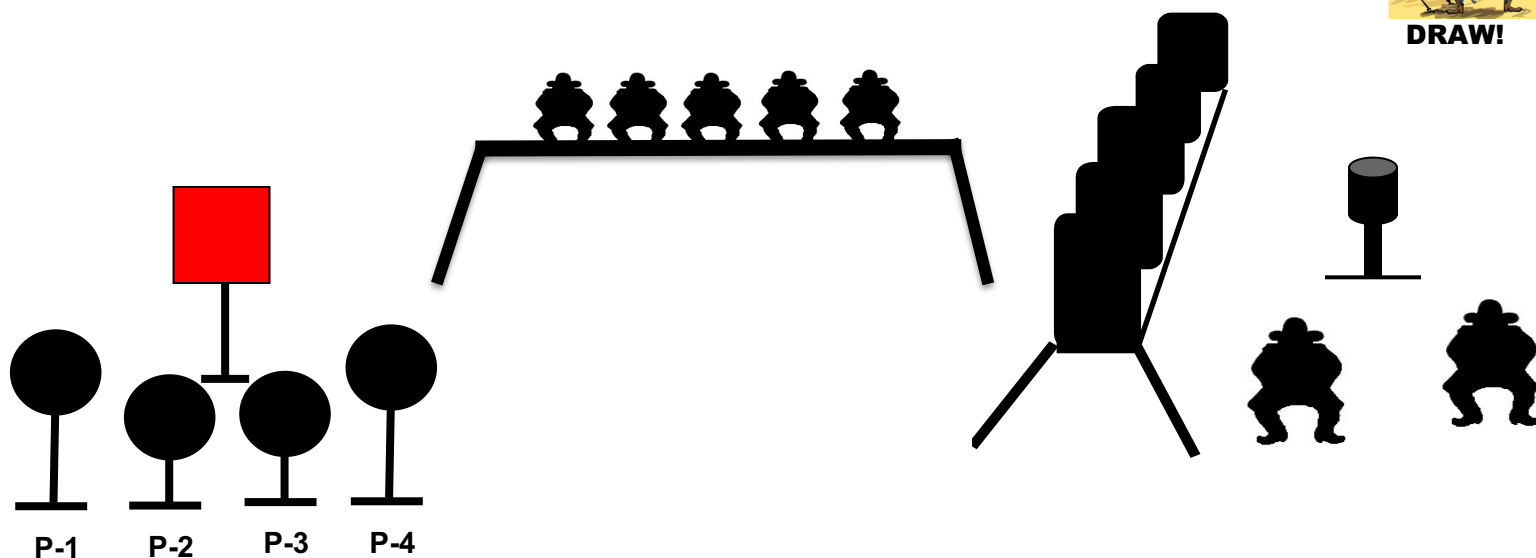

POSITION 1

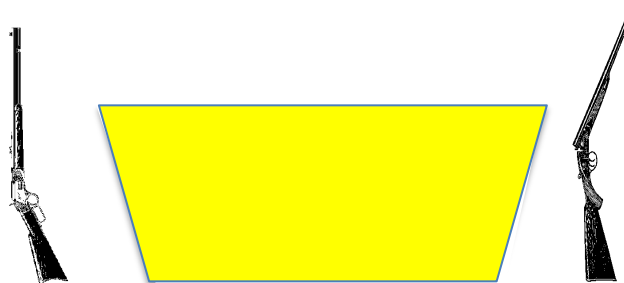

POSITION 2

STAGING OF FIREARMS:

RIFLE LOADED & OPEN EMPTY SHOTGUN STAGED AT POSITION 2, REVOLVERS LOADED & HOLSTERED.

HOW TO SHOOT THE STAGE:

START STANDING AT POSITION 2 WITH HANDS ON YOUR RIFLE, SHOOTER INDICATES READY BY SAYING: "THOSE THAT DON'T WANT TO GET SHOT BEST MOVE OUT THE BACK!"

AT THE BEEP, FROM POSITION 2, WITH RIFLE ENGAGE THE 5 COWBOYS ON THE RACK AND THE FIVE TOMBSTONES ON THE OTHER RACK FOR A TOTAL OF 10 ROUNDS. YOU MAY START ON EITHER RACK. FROM THE WATER TROUGH WITH YOUR SHOTGUN, ENGAGE THE 2 COWBOYS UNTIL DOWN.

FROM POSITION 1 WITH REVOLVERS, SWEEP P1-4 FROM THE LEFT, PLACE THE 5TH ROUND ON THE RED "P" TARGET, AND SWEEP P4-P1 AND PLACE THE 5TH ROUND ON THE RED "P" TARGET. (TWO 4 ROUND SWEEPS FROM OPPOSITE DIRECTIONS)

NOTE: ANY KNOCKDOWNS ARE STILL STANDING FROM THE COWBOY PLATE RACK OR TOMBSTONE RACK YOU MAY MAKE UP BY ENGAGING THE BELL WITH THE CORRESPONDING NUMBER OF ROUNDS WITH YOUR SHOTGUN AT THE END OF THE SHOTGUN STRING.

NOTE: ANY KNOCKDOWNS THAT REMAIN STANDING OR ARE NOT MADE UP WITH THE SHOTGUN WILL COUNT AS MISSES.

END OF STAGE

NOTE: ONE FOOT MUST BE BEHIND THE PROP WHILE ENGAGING TARGETS

GUN ORDER: ANY, RIFLE MAY NOT BE LAST

REVOLVERS (10)

RIFLE (10)

SHOTGUN (4+)

STAGE 6: January 2022



DRAW!

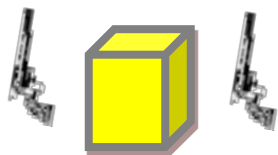
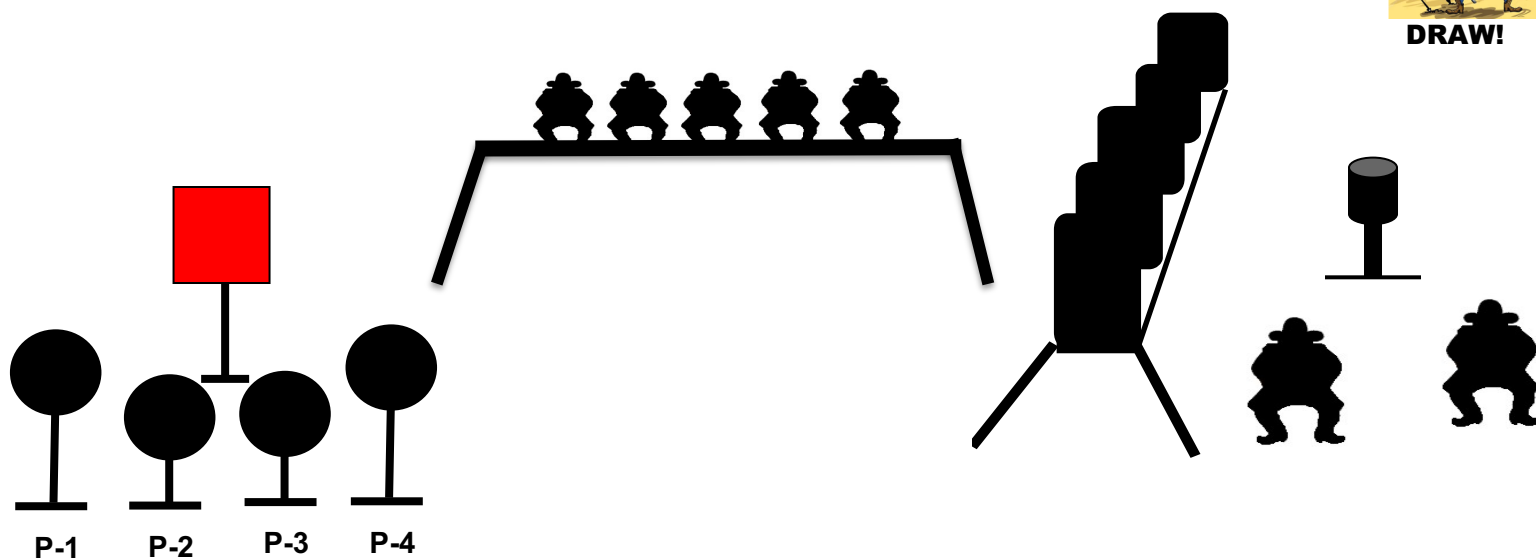

POSITION 1

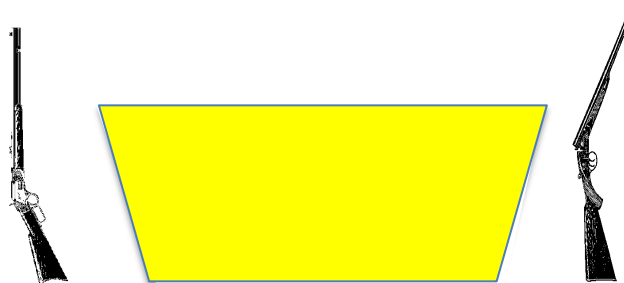

POSITION 2

STAGING OF FIREARMS:

RIFLE LOADED & OPEN EMPTY SHOTGUN STAGED AT POSITION 2, REVOLVERS LOADED & HOLSTERED.

HOW TO SHOOT THE STAGE:

START STANDING AT POSITION 1 WITH HAND(S) ON YOUR REVOLVER(S), SHOOTER INDICATES READY BY SAYING: "DESERVING HAS NOTHING TO DO WITH IT!"

AT THE BEEP FROM POSITION 1 WITH REVOLVERS ENGAGE THE RED "P" TARGET WITH 3 ROUNDS, & PLACE ONE ROUND ON EACH P1 & P2, REPEAT THE SEQUENCE USING THE RED TARGET AND P3 & P4 FOR 10 ROUNDS. (ROUND COUNT)

FROM POSITION 2, WITH RIFLE ALTERNATE BETWEEN THE 5 COWBOYS ON THE RACK AND THE FIVE TOMBSTONES ON THE OTHER RACK FOR A TOTAL OF 10 ROUNDS. YOU MAY START ON EITHER RACK. FROM THE WATER TROUGH WITH YOUR SHOTGUN, ENGAGE THE 2 COWBOYS UNTIL DOWN.

NOTE: ANY KNOCKDOWNS ARE STILL STANDING FROM THE COWBOY PLATE RACK OR TOMBSTONE RACK YOU MAY MAKE UP BY ENGAGING THE BELL WITH THE CORRESPONDING NUMBER OF ROUNDS WITH YOUR SHOTGUN AT THE END OF THE SHOTGUN STRING.

NOTE: ANY KNOCKDOWNS THAT REMAIN STANDING OR ARE NOT MADE UP WITH THE SHOTGUN WILL COUNT AS MISSES.

END OF STAGE

NOTE: ONE FOOT MUST BE BEHIND THE PROP WHILE ENGAGING TARGETS

GUN ORDER: ANY, RIFLE MAY NOT BE LAST

REVOLVERS (10)

RIFLE (10)

SHOTGUN (4+)

Target and Prop Requirements

WRG, January 2022

Stages 1 & 2

Rifle & Revolver Targets:
10 Squares

Stands:
10

Props:
2 Gun Horses

Shotgun Targets:
4 Coffin Lid Knockdowns

Stages 3 & 4

Rifle & Revolver Targets:
Two 20" Circles, Two 20 Squares (pistol)
Two 18" Squares, Two 18" Circles (rifle)

Stands:
8

Props:
Gun Horse, Cactus, Sawhorse

Shotgun Targets:
2 Cowboys, 2 Cacti

Stages 5 & 6

Rifle & Revolver Targets:
Cowboy Plate Rack, Tombstone Rack
Four 20" Circles, One 20" Square

Stands:
5

Props:
Water Trough, Hay Bale

Shotgun Targets:
2 Cowboys, Bell

Totals

Shotgun Targets: 4 Cowboys, 2 Cacti, 4 Coffin Lids

Props: 3 Gun Horses, 1 Hay Bale, Cactus, Water Trough,
Sawhorse